

# ENERGIZER NH15-1600

**AA**

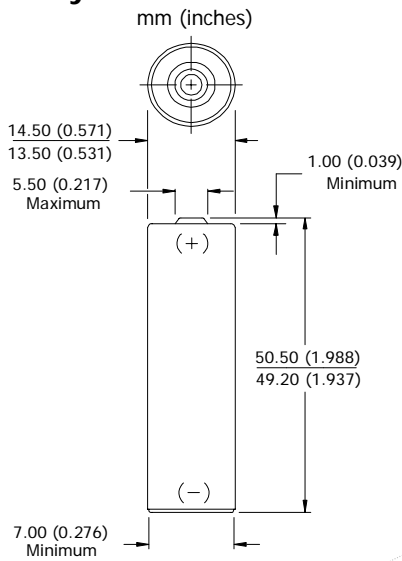

## Industry Standard Dimensions



## Discharge Characteristics

Typical Performance at 21°C (70°F)

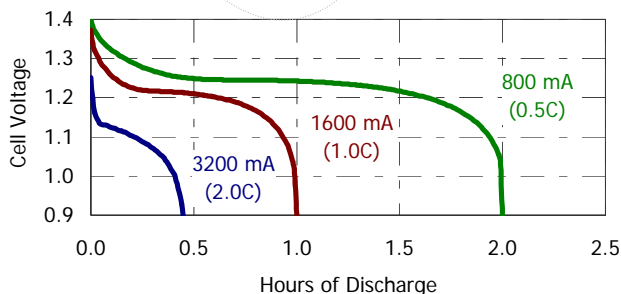
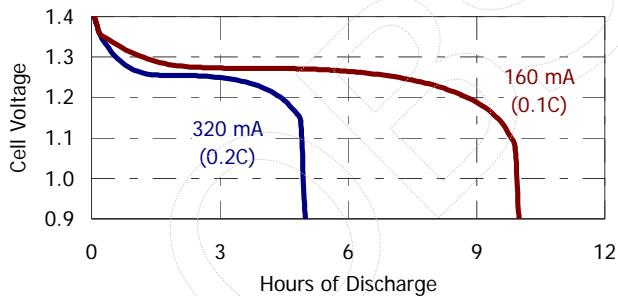

## Specifications

<b>Classification:</b>	Rechargeable
<b>Chemical System:</b>	Nickel-Metal Hydride (NiMH)
<b>Designation:</b>	ANSI-1.2H2
<b>Nominal Voltage:</b>	1.2 Volts
<b>Rated Capacity:</b>	1600 mAh* at 21°C (70°F)
<b>Typical Weight:</b>	28.0 grams (1.0 oz.)
<b>Typical Volume:</b>	8.3 cubic centimeters (0.5 cubic inch)
<b>Terminals:</b>	Flat Contact
<b>Jacket:</b>	Plastic

\* Based on 320 mA (0.2C rate) continuous discharge to 1.0 volts.

## Internal Resistance:

The internal resistance of the cell varies with state of charge, as follows:

<u>Cell Charged</u>	<u>Cell 1/2 Discharged</u>
30 milliohms	40 milliohms
(tolerance of ±20% applies to above values)	

## AC Impedance (no load):

The impedance of the charged cell varies with frequency, as follows:

<u>Frequency (Hz)</u>	<u>Impedance (milliohms)</u> (charged cell)
1000	12

Above values based on AC current set at 1.0 ampere  
Value tolerances are ±20%.

## Operating and Storage Temperatures:

To maintain maximum performance, observe the following general guidelines regarding environmental conditions:

Charge:	0°C to 40°C (32°F to 104°F)
Discharge:	0°C to 50°C (32°F to 122°F)
Storage:	-20°C to 30°C (-4°F to 86°F)
Humidity:	65±20%

**NOTE:** Operating at extreme temperatures, will significantly impact battery cycle life.

## Important Notice

This data sheet contains typical information specific to products manufactured at the time of its publication.

©Energizer Holdings, Inc. - Contents herein do not constitute a warranty.